

TR91

MAIN FEATURES

- Up to 30A switching in SPST and 20A switching in SPDT arrangements.
- Available as an open-frame relay, with a snap-on dust cover or with an immersion cleanable, plastic sealed case.
- Meets UL508 and UL873 spacing requirements.
- Available with UL class B & class F Insulation materials.
- UL & cUL recognized.

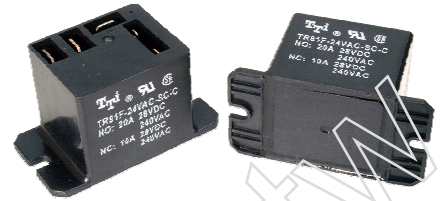

APPLICATIONS

- Used for power switching, Electrical Heater, ventilator, Air conditioning, Refrigerating, Automobile and House-hold Appliance.

ORDERING INFORMATION

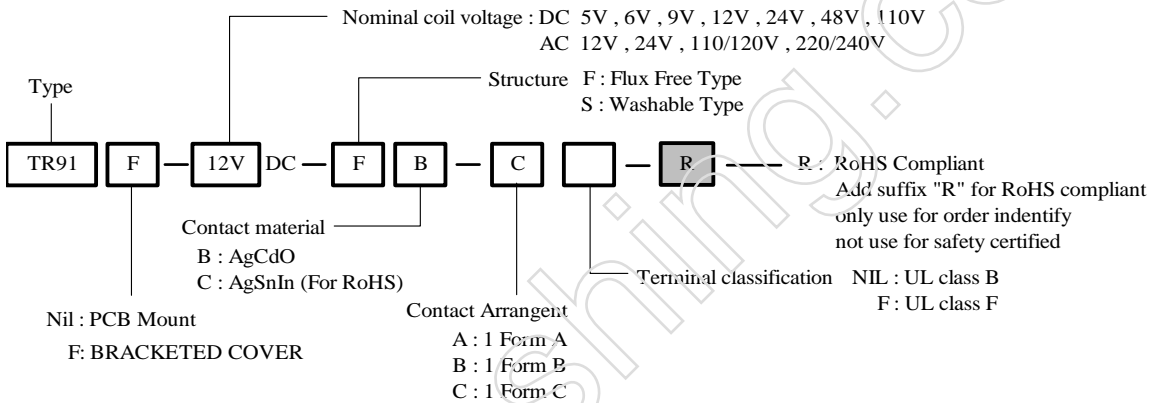

DIMENSION (unit:mm)

DRILLING (unit:mm)

WIRING DIAGRAM

PCB Mount Type

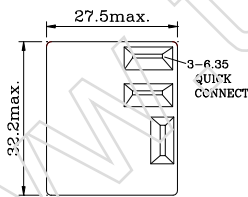

Bracketed Cover Type
Coil Terminal : 2.8mm

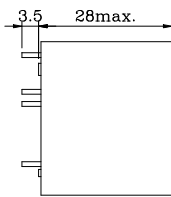
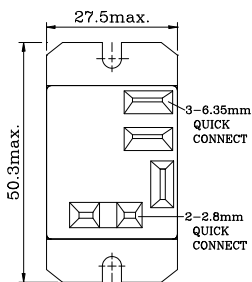

Mounting (mm)
(Bottom views)

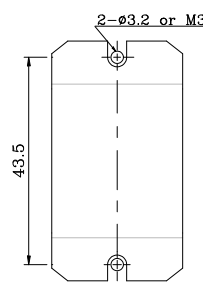
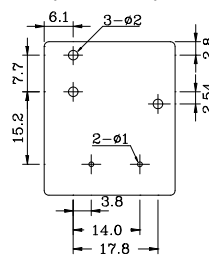

Wiring Diagrams
(Bottom views)

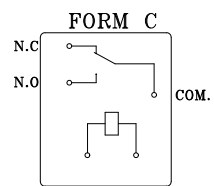
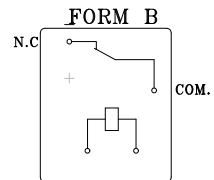
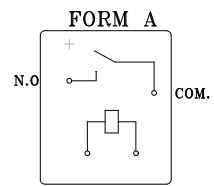

COIL DATA CHART (AT20°C)

Coil Sensitivity	Coil Nominal Voltage	Nominal Current	Coil Resistance	Power Consumption	Pull-In Voltage	Drop-Out Voltage	Max-Allowable Voltage	
TR91	DC Type	Vdc	mA	$\Omega \pm 10\%$	W	Vdc	Vdc	
		5	185	28	abt. 0.9	75% Max.	10% Max.	110%
		6	150	40				
		9	93	90				
		12	77	160				
		24	36	640				
		48	19	2560				
	110	8	13445					
	AC Type	Vac	mA	$\Omega \pm 10\%$	VA	Vac	Vac	Vac
		12	167	27	abt. 2.0	75% Max.	30% Max.	110%
		24	83	120				
		110	19	2360				
		120	17	3040				
		220	9.5	13490				

CONTACT RATING

Item	Type	TR91		
		FORM A	FORM C	
			N/O	N/C
UL/CUR		40A 240VAC 2HP 250/277VAC	40A 240VAC 2HP 250/277VAC	30A 240VAC 30A 30VDC 1.5HP 250VAC
Switching Voltage (Max.)		250VAC / 30VDC		
Switching Voltage (Max.)		40A	40A	30A
Switching Power (Max.)		7200VA / 1100W	4800VA / 720W	2400VA / 360W

PERFORMANCE (at initial value)

Item	Type	TR91
Contact Resistance		100m Ω Max.
Operation Time		DC : 15msec Max., AC : 20msec Max.
Release Time		DC : 10msec Max., AC : 15msec Max.
Dielectric Strength	Between coil & contact Between contacts	1500VAC 50/60HZ (1 minute) 1500VAC
Insulation Resistance		1000 M Ω Min. (500VDC)
Max. ON/OFF Switching	Mechanically Electrically	300 operation/min 30 operation/min
Operating Ambient Temperature		-55°C to +85°C (operating) -55°C to +155°C (storage)
Operating Humidity		45 to 80% RH
Coil Temperature Rise		60 deg. Max.
Vibration	Endurance Error Operation	10 to 55Hz Double Amplitude 1.5mm 10 to 55Hz Double Amplitude 1.5mm
Shock	Endurance Error Operation	1000 m/sec (abt. 100g's) 100 m/sec (abt. 10g's)
Life Expectancy	Mechanically Electrically	10×10^6 10×10^4
Weight		abt. 33grs.
UL & cUL		E156406

USEFUL CURVES

DC Coil Sealed

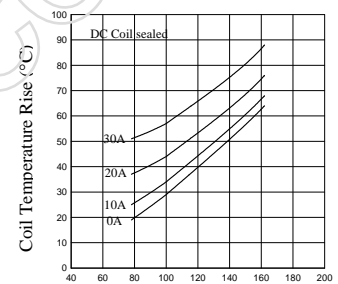

Coil Voltage (% of Nominal Voltage)

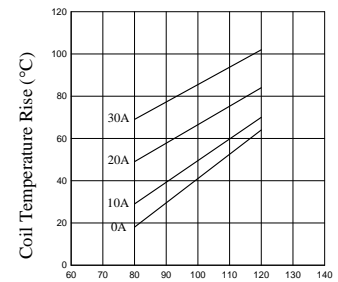

Coil Voltage (% of Nominal Voltage)

This datasheet for reference and subject to change without notice. Please double check final specification with Tai-Shing.