

BRIGHT LED ELECTRONICS CORP.

●Device Number : BIR-BM13J4G

Page: 2

●Absolute Maximum Rating(Ta=25°C)

Version:1.0

Item	Symbol	Rating	Unit
Reverse Voltage	V _r	5	V
Reverse Current	I _r	100	μA
Power Dissipation	P _d	100	mW
Forward Current	I _f	100	mA
Peak Forward Current(*1)	I _{fp}	1.0	A
Operating Temperature	T _{opr}	-45 ~ +85	°C
Storage Temperature	T _{stg}	-45 ~ +100	°C
Soldering Temperature(*2)	T _{sol}	260	°C

(*1)、Pulse Width=10μs,10%Duty Cycle

(*2)、For 5 Sec

●Electrical And Optical Characteristics(Ta=25°C)

Parameter	Symbol	Condition	BIN CODE	Min.	Typ.	Max.	Unit
Forward Voltage	V _f	I _f =50mA	—	—	1.2	1.5	V
Spectral Line Half-Width	△λ	I _f =20mA	—	—	50	—	nm
Radiant Power	I _e	I _f =50mA	13	16.5	—	31.2	mW/sr
			14	23.1	—	43.7	
			15	32.3	—	61.3	
			16	45.3	—	85.8	
Viewing Angle	2θ 1/2	I _f =20mA	—	—	20	—	deg
Peak Wavelength	λ _p	I _f =20mA	—	—	940	—	nm
Rise Time	T _r	I _{fp} =20mA, R _i =1kΩ	—	—	500	—	ns
Fall Time	T _f			—	500	—	ns

BRIGHT LED ELECTRONICS CORP.

●Device Number: BIR-BM13J4G

Page: 3

●Dimensions

Version: 1.0

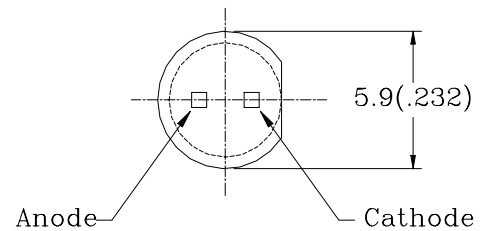
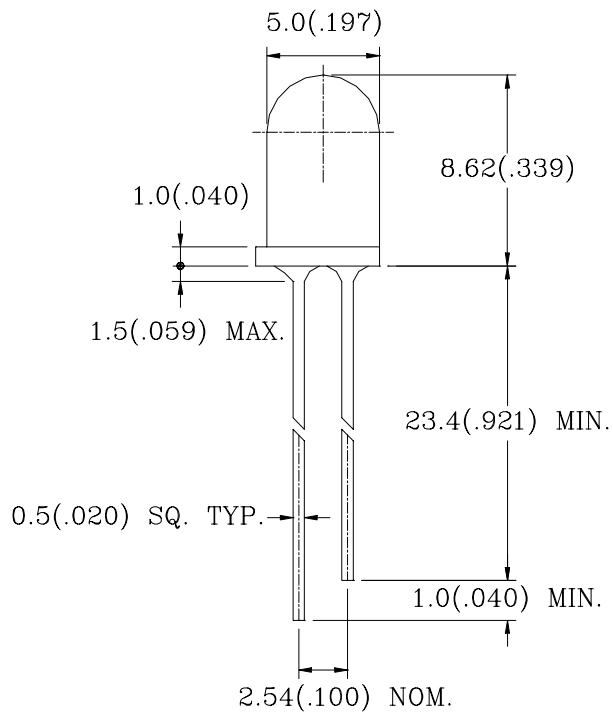

Notes:

- 1、All dimensions are in millimeters(inches).
- 2、Tolerance is $\pm 0.25\text{mm}(0.01'')$ unless otherwise specified.
- 3、Lead spacing is measured where the leads emerge from the package.
- 4、Specifications are subject to change without notice.
- 5、Lens appearance :water clear.

BRIGHT LED ELECTRONICS CORP.

●Device Number: BIR-BM13J4G

Page: 4

●Electrical And Optical Curves(Ta=25°C)

Version: 1.0

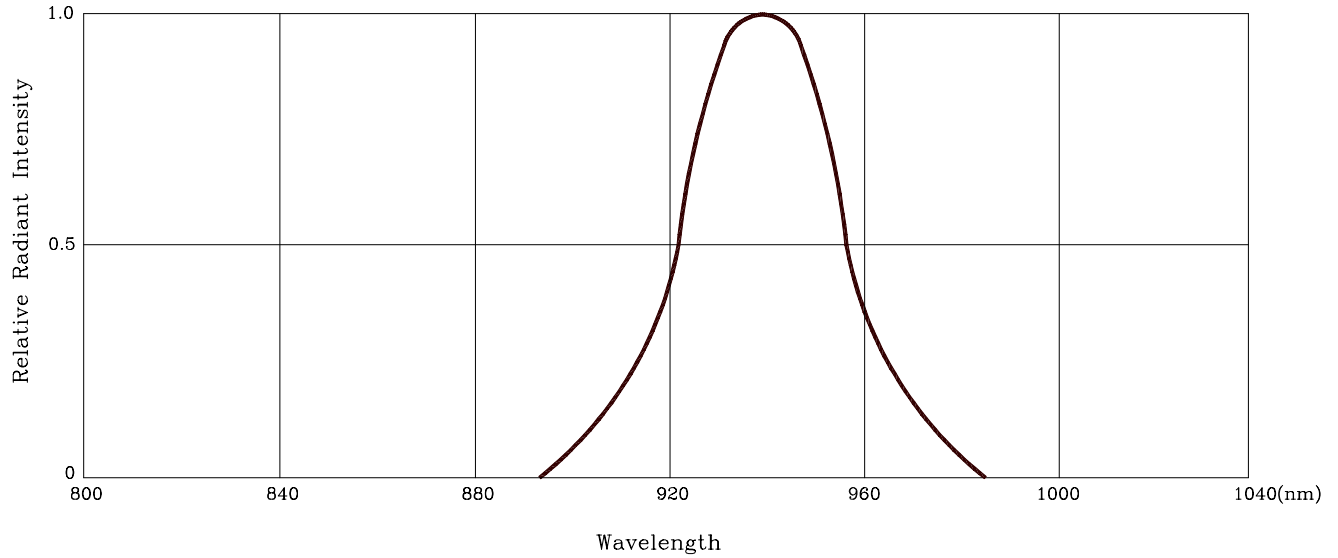

FIG.2 Forward Current Vs. Forward Voltage

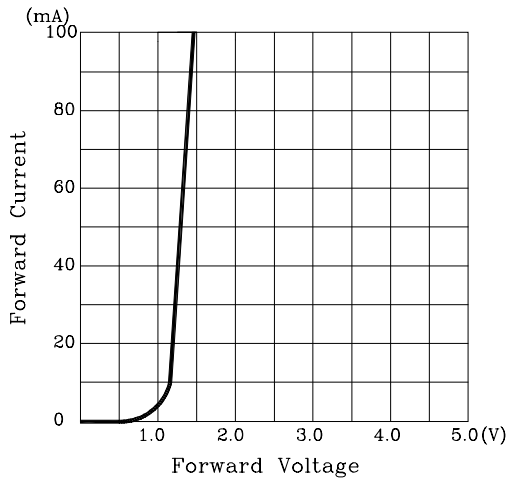

FIG.3 Relative Radiant Intensity Vs. Ambient Temperature

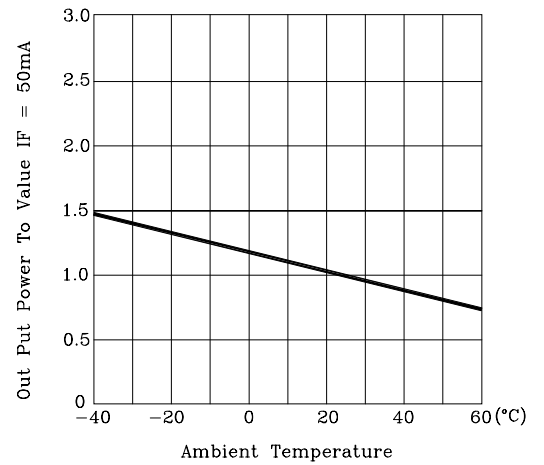

FIG.4 Relative Radiant Vs. Forward Current

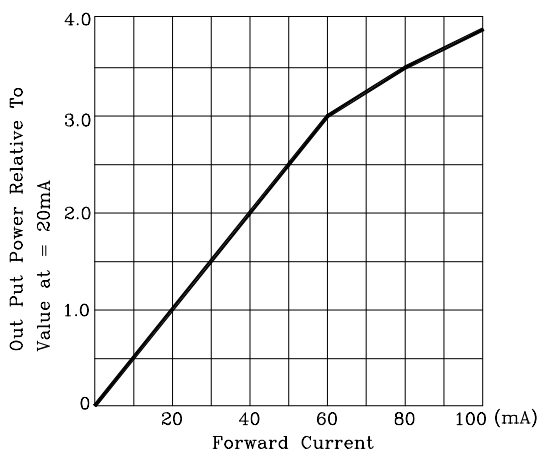
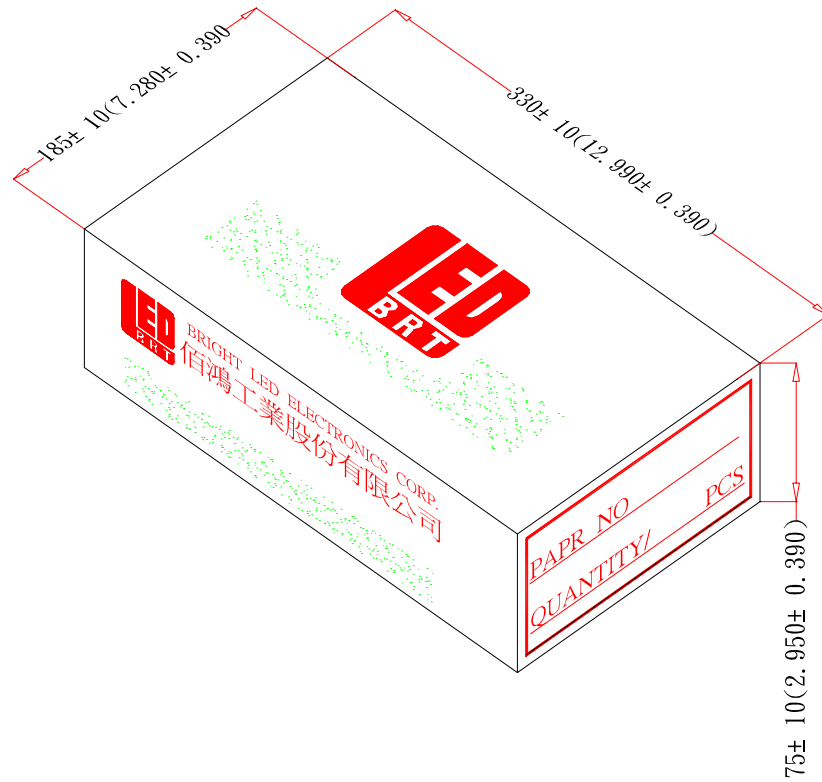

FIG.5 Radiant Diagram

BRIGHT LED ELECTRONICS CORP.

- Device Number: BIR-BM13J4G
- Packaging Box Dimensions

Page: 5
Version: 1.0



●Packaging Bag Dimensions

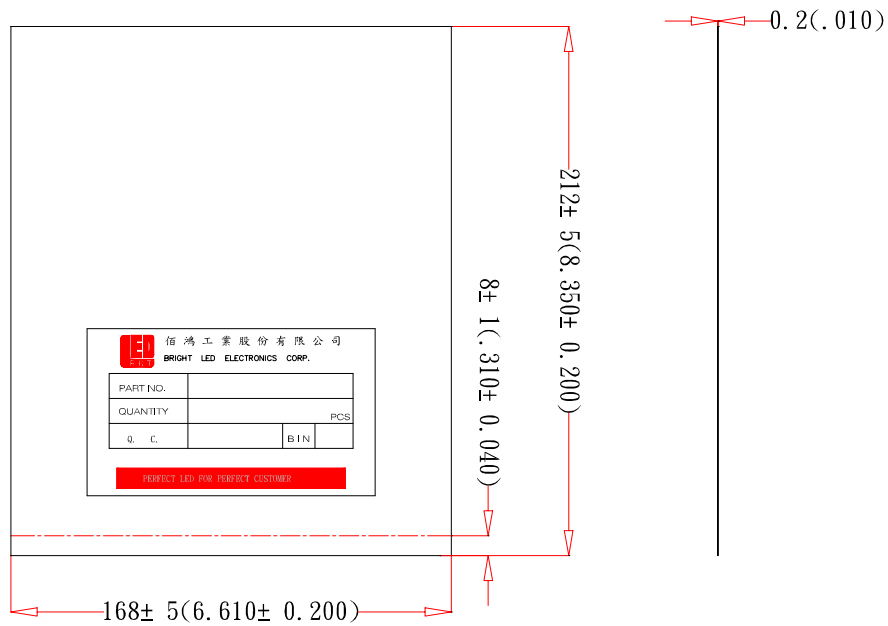

Notes:

- 1、500pcs per bag, 5Kpcs per box.
- 2、All dimensions are in millimeters(inches).
- 3、Specifications are subject to change without notice.