

Features:

- 3.2mmx1.6mm SMD, 1.1mm THICKNESS.
- ULTRA BRIGHTNESS.
- LOW POWER CONSUMPTION.
- WIDE VIEWING ANGLE.
- IDEAL FOR BACKLIGHT AND INDICATOR.
- PACKAGE : 3KPCS/REEL.

■ Electrical-optical characteristics: (Ta=25°C) (Test Condition: IF=20mA)

Part Number	Chip			Lens Type	Forward Voltage(VF) Unit:V		Luminous Intensity (lv) Unit:ucd		Viewing Angle 2 θ 1/2 (deg)
	Emitted Color	Material	I _P (nm)		Typ	Max	Min.	Typ.	
FYLS-1206UDR	Ultra Red	AlGaAs	655	Water Clear	2.10	2.50	22	55	140
FYLS-1206UHR	Ultra Red	AlGaAs	645		2.10	2.60	30	80	
FYLS-1206UEC	Ultra Orange	AlGaAs	630		2.10	2.50	30	80	
FYLS-1206UHD	Ultra Orange	AlGaAs	618		2.10	2.60	50	110	
FYLS-1206UYO	Ultra Amber	AlGaInP	610		2.10	2.60	25	65	
FYLS-1206UYC	Ultra Yellow	AlGaInP	593		2.10	2.60	25	70	
FYLS-1206UGC	Ultra Green	AlGaInP	575		2.20	2.70	15	45	
FYLS-1206PGC	Ultra Pure Green	InGaN	525		3.50	4.20	15	100	
FYLS-1206BGC	Ultra Bluish Green	InGaN	505		3.50	4.20	30	110	
FYLS-1206DNB	Blue	InGaN	470		3.50	4.20	15	40	
FYLS-1206UBC	Ultra Blue	InGaN	470		3.50	4.20	10	30	
FYLS-1206UWC	Ultra White	InGaN	/		3.50	4.20	100	270	

■ Absolute maximum ratings (Ta=25°C)

Parameter	UDR	UHR	UE	UHD	UYO	UY	UG	PG	BG	DNB	UB	UW	Unit
Forward Current I _F	30	30	30	30	30	30	30	30	30	30	30	30	mA
Power Dissipation P _d	78	78	78	78	78	78	78	78	78	78	78	78	mW
Reverse Voltage V _R	5	5	5	5	5	5	5	5	5	5	5	5	V
Peak Forward Current I _{PF} (Duty 1/10 @1KHZ)	100	100	100	100	100	100	100	100	100	100	100	100	mA
Operation Temperature T _{OPR}	-30 to +80												
Storage Temperature T _{STG}	-40 to +85												
Lead Soldering Temperature T _{SOL}	Max.260 ± 5 for 3 sec Max. (1.6mm from the base of the epoxy bulb)												

■ Package configuration & Internal circuit diagram:

FYLS-1206xx

Package Outline Drawing

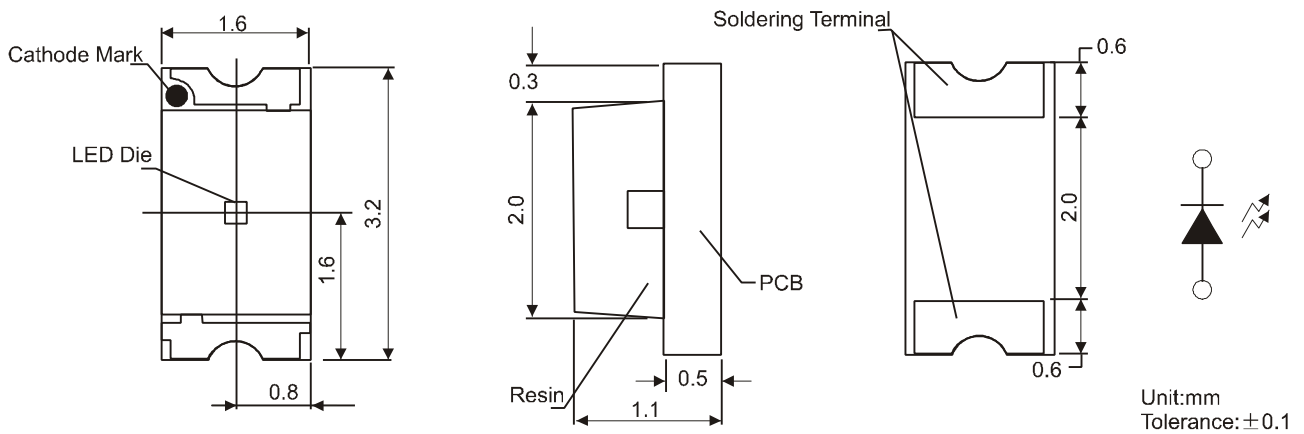

Recommended Soldering Pad Dimensions

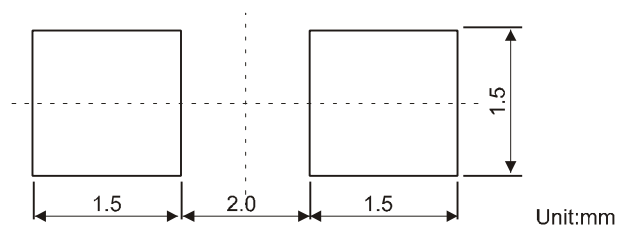

Notes:

All dimensions are in millimeters (inches)
Tolerance is ±0.25(0.01")unless otherwise noted.
Specifications are subject to change without notice.

■ **Typical electrical-optical characteristics curves:**

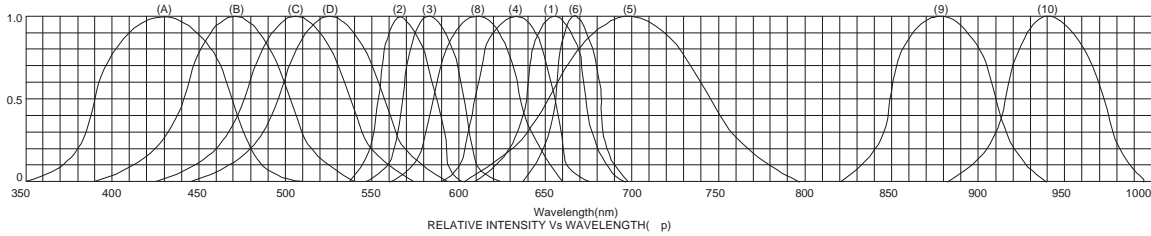

- | | |
|---|--------------------------------------|
| (1) - GaAsP/GaAs 655nm/Red | (9) - GaAlAs 880nm |
| (2) - GaP 570nm/Yellow Green | (10) - GaAs/GaAs & GaAlAs/GaAs 940nm |
| (3) - GaAsP/GaP 585nm/Yellow | (A) - GaN/SiC 430nm/Blue |
| (4) - GaAsP/GaP 635nm/Orange & Hi-Eff Red | (B) - InGaN/SiC 470nm/Blue |
| (5) - GaP 700nm/Bright Red | (C) - InGaN/SiC 505nm/Ultra Green |
| (6) - GaAlAs/GaAs 660nm/Super Red | (D) - InGaAl/SiC 525nm/Ultra Green |
| (8) - GaAsP/GaP 610nm/Super Red | |

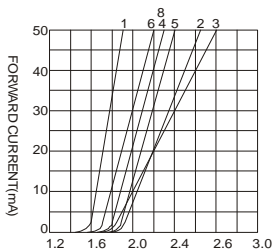

FORWARD VOLTAGE (Vf)
FORWARD CURRENT VS.
FORWARD VOLTAGE

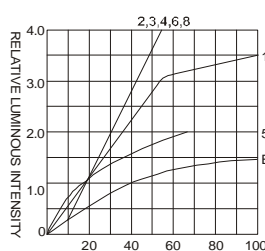

FORWARD CURRENT (mA)
RELATIVE LUMINOUS
INTENSITY VS. FORWARD
CURRENT

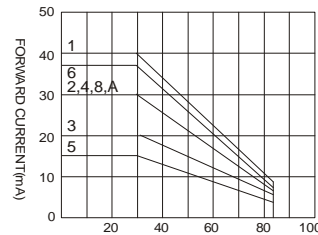

AMBIENT TEMPERATURE Ta()
FORWARD CURRENT VS. AMBIENT
TEMPERATURE

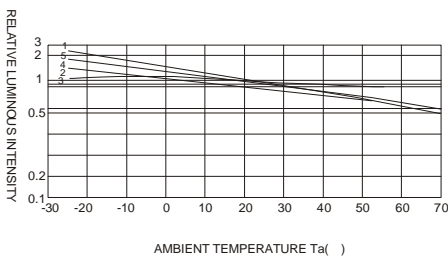

AMBIENT TEMPERATURE Ta()

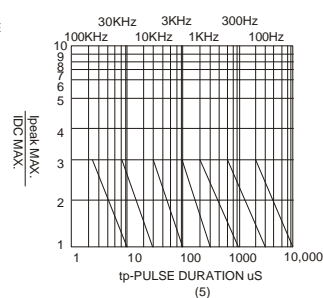
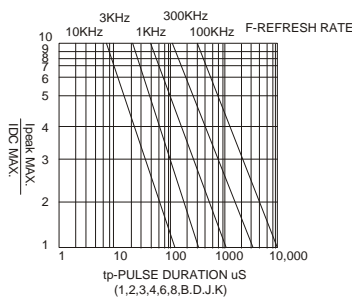

NOTE:25 free air temperature unless otherwise specified

■ **Tape Specifications**

Unit : mm

Tolerance : ± 0.1

