

Features

- Efficiency up to 97%, Non isolated, no need for heatsinks
- Pin-out compatible with LM78XX Linear
- Very low profile (L*W*H=11.5*7.5*10.2)
- Wide input range (4.75V ~ 34V)
- Short circuit protection, Thermal shutdown
- Non standard outputs available as specials between 1.5V ~ 15.5V
- Low ripple and noise

INNOLINE
DC/DC-Converter

R-78xx-0.5 Series

0.5 AMP

SIP3

Single Output

Selection Guide

Part Number	Input Range (V)	Output Voltage (V)	Output Current (A)	Efficiency (%)	
				Min. Vin	Max. Vin
SIP3	(V)	(V)	(A)	(%)	(%)
R-781.5-0.5	4.75 – 30	1.5	0.5	73	63
R-781.8-0.5	4.75 – 34	1.8	0.5	82	71
R-782.5-0.5	4.75 – 34	2.5	0.5	87	77
R-783.3-0.5	4.75 – 34	3.3	0.5	91	81
R-785.0-0.5	6.5 – 34	5.0	0.5	94	86
R-786.5-0.5	8.0 – 34	6.5	0.5	95	88
R-789.0-0.5	11 – 34	9.0	0.5	96	92
R-7812-0.5	15 – 34	12	0.5	97	94
R-7815-0.5	18 – 34	15	0.5	97	95

Note 1: 1.5V Output can be unstable with $V_{in} > 30VDC$

Description

The R-78xx-Series high efficiency switching regulators are ideally suited to replace 78xx linear regulators and are pin compatible. The efficiency of up to 97% means that very little energy is wasted as heat so there is no need for any heat sinks with their additional space and mounting costs. Low ripple and noise figures and a short circuit input current of typically only 7mA round off the specifications of this versatile converter series.

This R-78xx-0.5 is fully certified to EN 60601-1-2 (Medical Equipment), EN 55022 (Emissions), and EN55024 (Immunity) EMC Standards.



RECOM

Derating-Graph (Ambient Temperature)

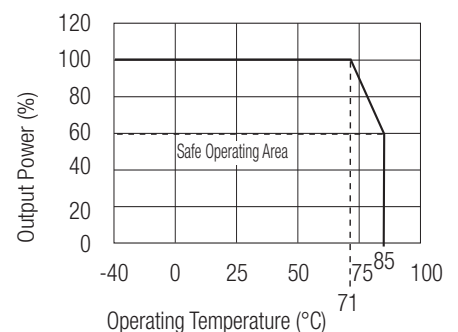

Specifications (refer to the standard application circuit, Ta: 25°C)

Characteristics	Conditions	Min.	Typ.	Max.
Input Voltage Range	1.5V	4.75		30.0V
	1.8V to 15.5V	4.75		34.0V
Output Voltage Range (for customized parts)	All Series	1.25		15.5V
Output Current	All Series	50		500mA
Output Current Limit	All Series			2000mA
Short Circuit Input Current	All Series		10	30mA
Internal Power Dissipation				0.4W
Short Circuit Protection			Continuous, automatic recovery	
Output Voltage Accuracy (At 100% Load)	All Series		±2	±3%
Line Voltage Regulation (Vin = min. to max. at full load)	1.5V to 6.5V		0.2	0.4%
	9V to 15.5V		0.1	0.2%
Load Regulation (10 to 100% full load)	1.5V to 6.5V		0.4	0.6%
	9V to 15.5V		0.25	0.4%
Dynamic Load Stability	100% <-> 50% load		±75mV	
	100% <-> 10% load			±100mV
Ripple & Noise (without Output Capacitor)	1.5V to 6.5V		20mVp-p	30mVp-p
	9V to 15.5V		30mVp-p	40mVp-p
Ripple & Noise (with Output Capacitor=100µF)	1.5V to 6.5V		15mVp-p	20mVp-p
	9V to 15.5V		25mVp-p	35mVp-p
Temperature Coefficient	-40°C ~ +85°C ambient			0.015%/°C
Max capacitance Load				220µF
Switching Frequency		280	330	380kHz
Quiescent Current	Vin = min. to max. at 0% load		5	7mA
Operating Temperature Range		-40°C		+85°C
Operating Case Temperature				+100°C
Storage Temperature Range		-55°C		+125°C
Case Thermal Impedance				70°C / W
Thermal Shutdown	Internal IC junction		+160°C	
MTBF (+25°C)	} Detailed Information see Application Notes chapter "MTBF"	using MIL-HDBK 217F		21098 x 10 ³ hours
(+71°C)		using MIL-HDBK 217F		4212 x 10 ³ hours

Standard Application Circuit

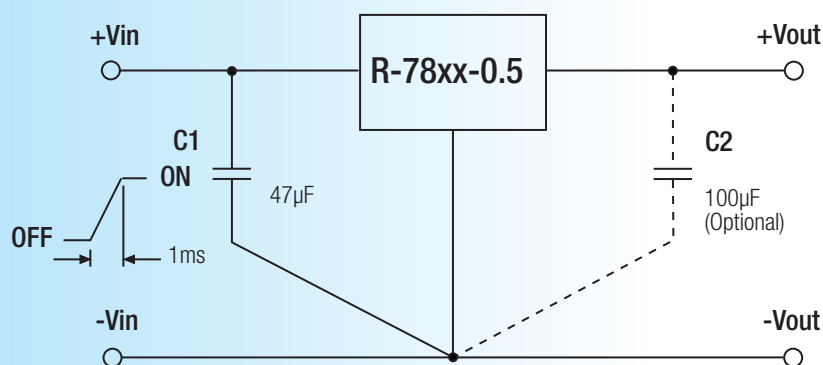

To protect the converter during power-up, use soft start Vin and C1=47µF

Characteristics

Efficiency

Ripple

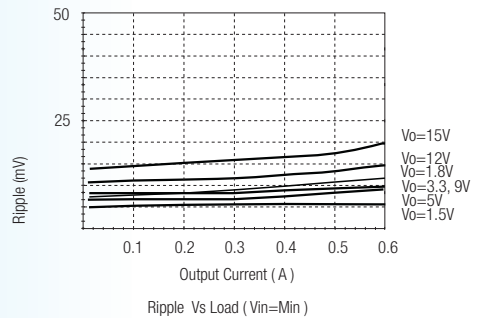
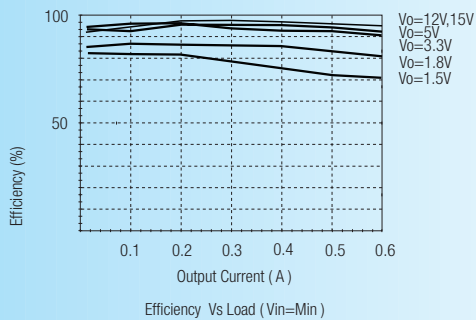
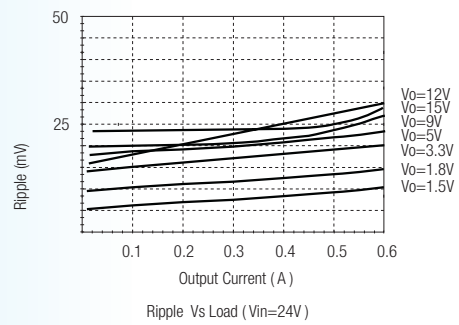
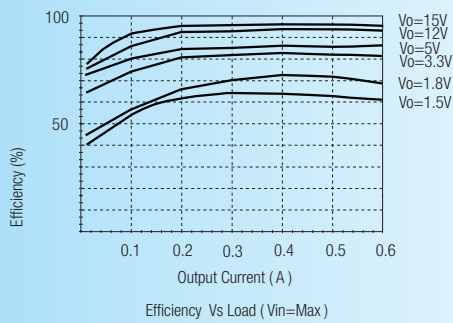
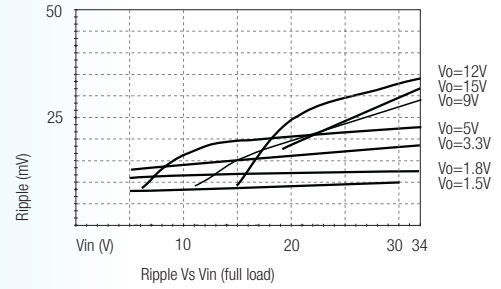
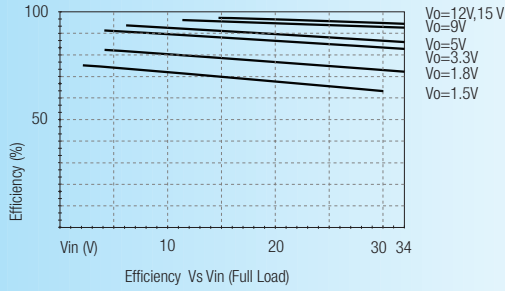

Application Examples

High efficiency, isolated, dual unregulated outputs

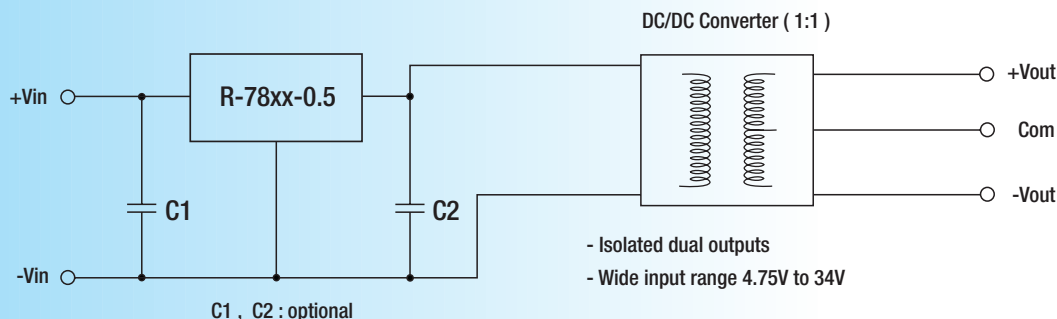

Isolated (up to 6KV), wide Input range regulated output

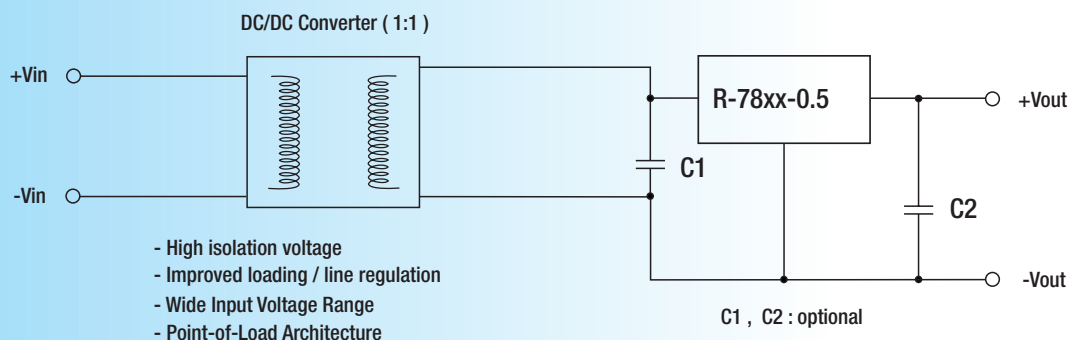

Package Style and Pinning (mm)

SIP3 PIN Package

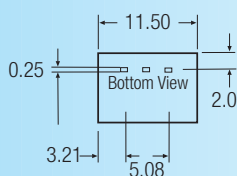
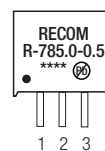
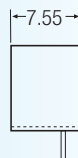
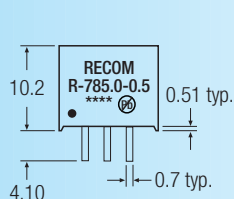

Recommended Footprint Details

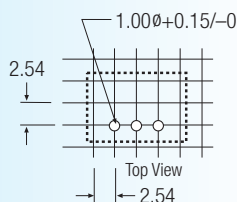

Pin Connections

Pin #	Connection
1	+Vin
2	GND
3	+Vout

xx.x ±0.5mm
xx.xx ±0.25mm