

Features

- Efficiency up to 94%, non-isolated, no need for heatsinks!
- Pin-out compatible with LM78XX Linears
- Very low profile (L*W*H=11.5*7.5*10.2mm)
- Wide input range (4.75V ~ 18V)
- Short circuit protection, thermal shutdown
- Non standard outputs available as specials between 1.5V ~5.5V
- Low ripple and noise

Selection Guide

Part Number	Input Range (V)	Output Voltage (V)	Output Current (A)	Efficiency	
				Min. Vin (%)	Max. Vin (%)
SIP3	(V)	(V)	(A)	(%)	(%)
R-781.8-1.0	4.75 – 18	1.8	1.0	82	76
R-782.5-1.0	4.75 – 18	2.5	1.0	87	81
R-783.3-1.0	4.75 – 18	3.3	1.0	90	84
R-785.0-1.0	6.5 – 18	5.0	1.0	94	89

Description

The R-78xx-1.0 series high efficiency switching regulators are ideally suited to replace 1 Amp 78xx linear regulators and are pin compatible. The efficiency of up to 97% means that very little energy is wasted as heat so there is no need for any heat sinks with their additional space and mounting costs. Low ripple and noise figures and a short circuit input current of typically only 10mA round off the specifications of this versatile converter series.

Specifications (typical at 25°C, 10% minimum load, unless otherwise specified)

Characteristics	Conditions	Min.	Typ.	Max.
Input Voltage Range	All Series	4.75		18V
Output Voltage Range	All Series	1.5		5.5V
Output Current	All Series	0		1000mA
Output Current Limit	All Series			3000mA
Short Circuit Input Current	All Series		10	30mA
Internal Power Dissipation				0.4W
Short Circuit Protection			Continuous, automatic recovery	
Output Voltage Accuracy (At 100% Load)	All Series		±2	±3%
Line Regulation (100% Load, Vin max.)	All Series		0.2	0.4%
Load Regulation (10 to 100% full load)	All Series		0.4	0.6%
Dynamic Load Stability	100% <-> 50% load		±85mV	±100mV
Ripple & Noise (20Mhz BW)	All Series		20mVp-p	30mVp-p
Temperature Coefficient	-40°C ~ +85°C ambient			0.015%/°C
Max capacitance Load				220µF
Switching Frequency		280	350	430kHz
Quiescent Current	Vin = min. to max. at 0% load		5	7mA
Operating Temperature Range		-40°C		+85°C
Operating Case Temperature (with derating)				+100°C
Storage Temperature Range		-55°C		+125°C
Case Thermal Impedance				70°C/W
Thermal Shutdown	Internal IC junction		+160°C	
Package Weight				1.9g
MTBF (+25°C)	Detailed Information see Application Notes chapter "MTBF"	using MIL-HDBK 217F		13338 x 10 ³ hours
(+71°C)		using MIL-HDBK 217F		3880 x 10 ³ hours

INNOLINE
DC/DC-Converter

R-78xx-1.0 Series

1.0 AMP
SIP3
Single Output



RECOM

Derating-Graph (Ambient Temperature)

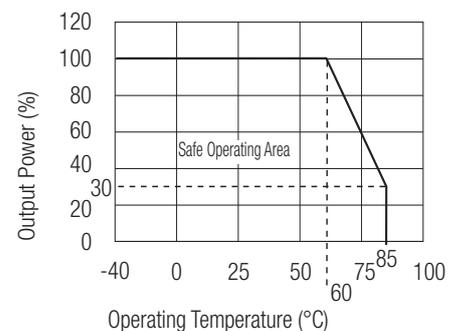

Standard Application Circuit

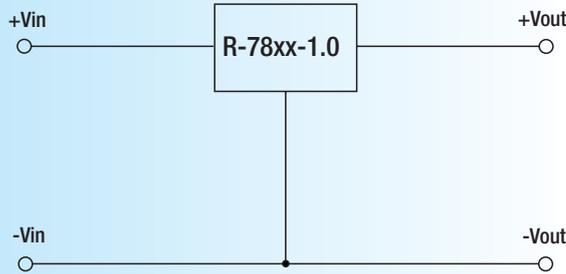

Add a blocking diode to Vout if current can flow backwards into the output, as this can damage the converter..

Characteristics

Efficiency

Ripple

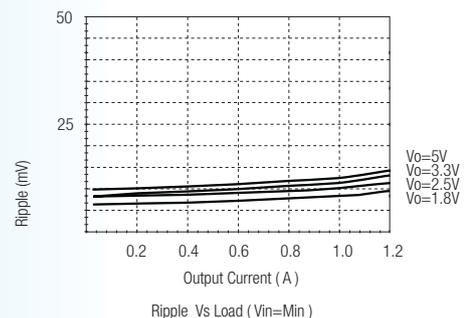
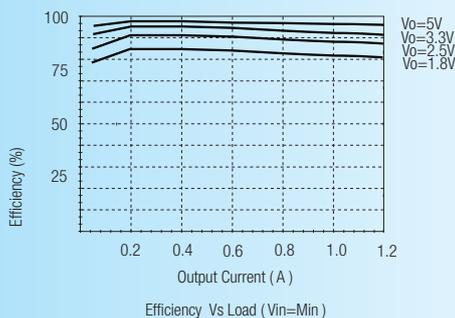
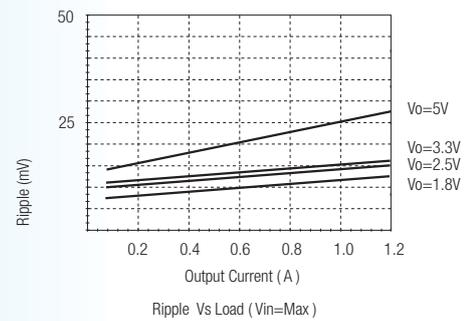
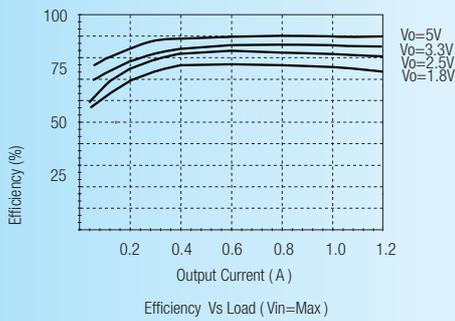
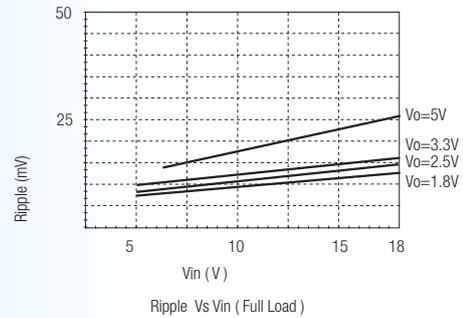
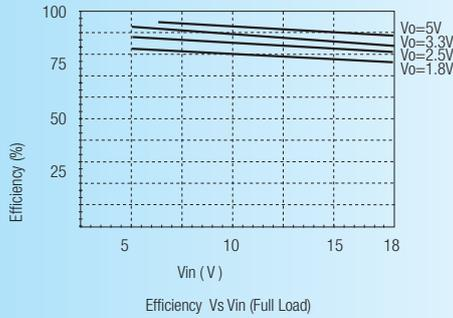

Application Examples

High efficiency, isolated, dual regulated outputs

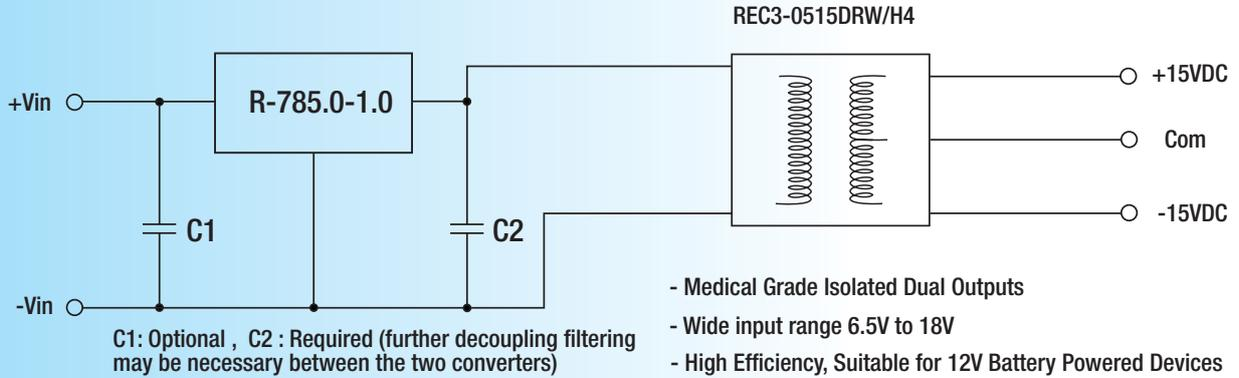

Isolated (up to 6KV), wide Input range regulated output

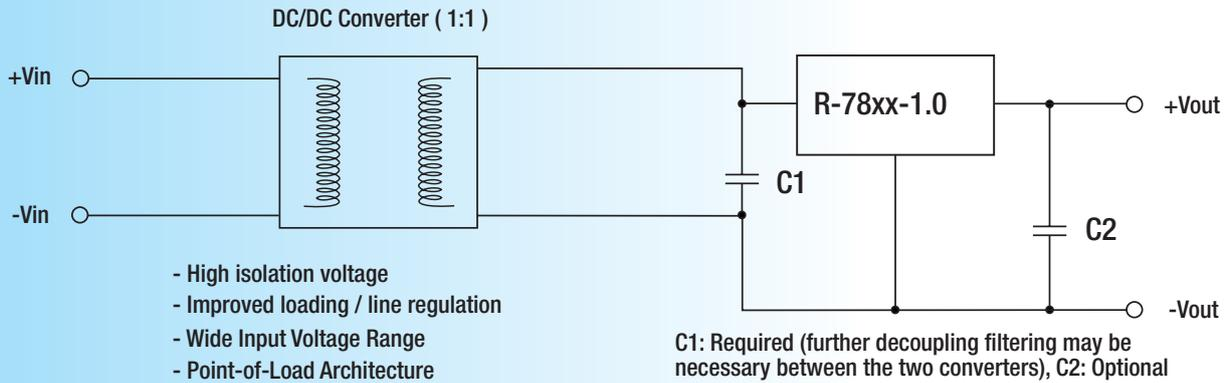

Package Style and Pinning (mm)

SIP3 PIN Package

3rd angle projection

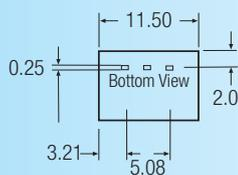
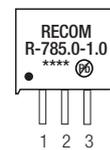
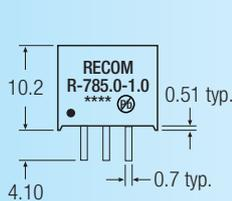

Recommended Footprint Details

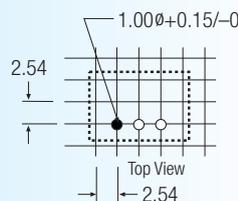

Pin Connections

Pin #	Connection
1	+Vin
2	GND
3	+Vout

xx.x ±0.5mm

xx.xx ±0.25mm